



# M6

**DVD MULTIMEDIA INTERNET RECEIVER  
WITH 6.75" LCD SCREEN, BUILT-IN NAVIGATION & BLUETOOTH**



# Precautions

Thank you for your purchase of the M6 entertainment system.

This owner's manual is a basic "Quick Start" style manual. It will provide basic information on the operation of all the features of your new M6.

After you have finished reading this manual, please keep it in a safe place for ready reference.

For a more detailed description of certain features of the M6, please use the internet and navigate to [www.magnadyne.com](http://www.magnadyne.com). Locate the M6 radio page and there you will find a "manuals" tab. Search the documents for the area of the M6 that you want more information on.

Only connect the unit to a 12-volt power supply with proper negative grounding.

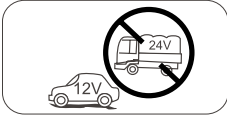

Never install this unit where the operation and condition for driving safely is compromised.



Never use the video display while the car is in motion. The use of video playback while driving is a violation of traffic laws and increases the risk of traffic accidents.



To ensure safe driving, please adjust the volume to a safe & comfortable level in case of emergency situations.

Never expose this unit, amplifier or speakers to moisture or water to prevent electronic sparks or fires.



Please don't change the fuse on the power cord without professional guidance, using an improper fuse may cause damage to this unit or even cause fire.

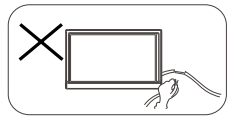

Please power off this unit at once and send it back to the after-sales service center or the dealer /distributor you purchased from if one of the following symptoms is found:

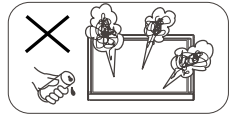

- (a). No audio output;
- (b). No image output;
- (c). Water or other obstacle enters the unit;
- (d). Smoking;
- (e). Peculiar smell.

To provide a clear demonstration and an alternative for easy understanding of the operation of this unit, graphic illustration was used. However, this illustration is not necessary printed as the actual image found on the unit.

## Precautions

### Warning

Operate the unit correctly according to the instruction manual to prevent unnecessary problems.

### CAUTIONS ON HANDLING

This product is a CLASS 1 LASER PRODUCT. Use of controls or adjustments or performance of procedures other than those specified herein may result in hazardous radiation exposure. Do not open covers and do not repair yourself. Refer servicing to qualified personnel.

### Two laser products

Wave length: CD: 780nm DVD: 650nm

Laser power: No hazardous radiation is emitted with safety protection.

To reduce the risk of fire electric shock, and annoying interference, use only the included components.

### Caution of disc using

1. **DO NOT use irregular shaped disc.**

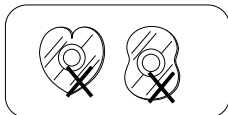

2. **Disc Cleaning.** Use a dry, soft cloth to wipe the disc from center to edge, only neutral detergent can be used.

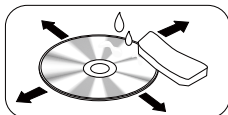

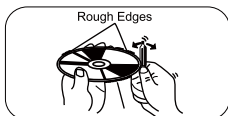

3. **When playing a new disc.** New disc may have some rough spots around the inner and outer edges. If such a disc is used, remove these rough spots with a pencil or ball-point pen, etc.



## Contents

Precautions .....	1
Control Panel .....	3
Remote Control.....	4
Basic Operations .....	6
Main menu.....	7
Disc Operation.....	7
Radio Operations.....	10
USB Operations.....	12
Bluetooth Operations.....	15
iPod/iPhone Operations.....	17
DVR-RECORDER (optional).....	18
SiriusXM Satellite Radio .....	19
Internet .....	22
Other Mode.....	23
Sound setting.....	23
System settings.....	24
Device Connections .....	26
Troubleshooting .....	30
Specifications.....	31

# Control Panel

Press [   ] button to turn on the unit.

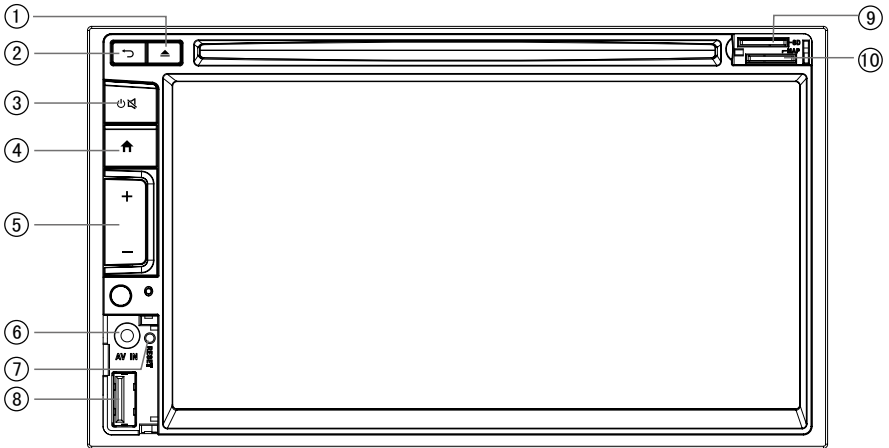

**1. [  ] Button**

Back to previous MENU.

**2.  Eject disc** (when disc inserted)

**3. [   ] Button**

- > Power "ON" (press)
- > Power "OFF" (long press)
- > Mute the Volume (press)

**4. [  ] Button**

Show main menu (press)  
Show main options(long press)

**5. Volume  / **

Increase / Decrease the volume

**6. AUX IN Socket**

**7. Reset**

Load factory settings

**8. USB Socket**

**9. SD card reader for media.**

**10. Map Card Slot**

# Remote Control

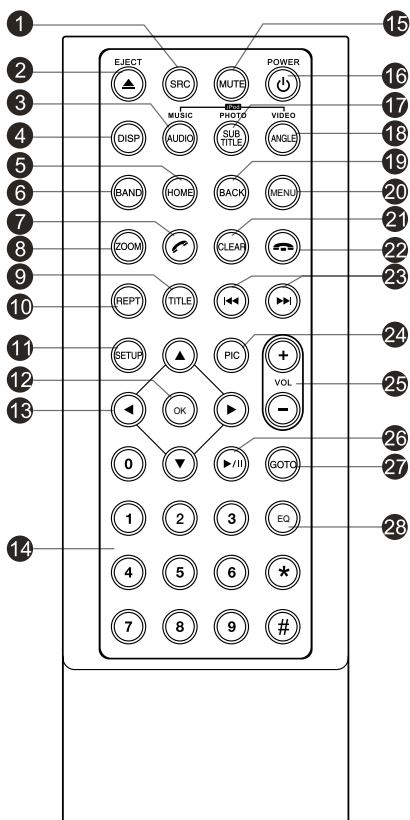

1. Change playing source in sequence
2. Eject the disc
3. Select audio language  
Show music catalog
4. Display playback information
5. Show home menu
6. Select radio band
7. Call out - Outgoing call
8. Zoom
9. DVD title
10. Repeat playback
11. Setup menu
12. Enter( OK key)
13. Move the cursor up/down/left/right.  
Up/down: Manual tuning
14. Numeric keys
15. Mute the volume
16. Unit power
17. Select DVD subtitle language
18. Select DVD angle
19. Return to previous display
20. Main menu
21. Clear information
22. Hang up
23. Previous/Next  
Auto tuning (long press)  
Fast backward/forward (long press)
24. Display settings
25. Adjust volume
26. Play / Pause
27. Go-to search
28. Enter the EQ setting

# Remote Control

## Notes of remote control using

- 1) Aim the remote control at the remote sensor on the unit.
- 2) Remove the battery from the remote control or insert a battery insulator if the battery has not been used for a month or longer.
- 3) DO NOT store the remote control under direct sunlight or in high temperature environment, or it may not function properly.
- 4) The battery can work for 6 months under normal conditions. If the remote control doesn't work, change the battery.
- 5) Use "button shaped" lithium battery "CR2025"(3V) only.
- 6) DO NOT recharge, disassemble, heat or expose the battery to fire.
- 7) Insert the battery in proper direction according to the (+) and (-).
- 8) Store the battery out of children reach it can be hazardous if swallowed to avoid the risk of accident.

## Uninstall Battery

Slide out the battery compartment tray at the bottom on the back of the remote control.

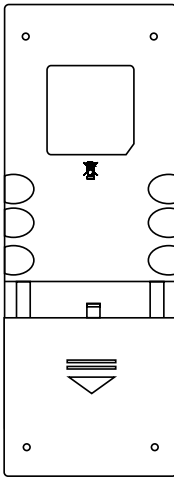

 PULL OUT

## Install Battery

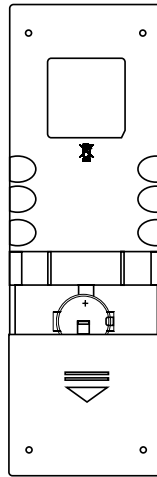

Use button-shaped lithium battery CR2025 (3V) only. Insert the battery to the battery tray with proper direction according to the (+) and (-) poles.



PUSH IN 

## Basic Operations

### Turn on/off the power

1. Press and release [  ] to turn the unit on.
2. Press and hold the [  ] to turn the unit off.

#### Note:

The unit will power on in the same state it was in when powered off.



### Mute

Press the [  ] button to mute the sound.

#### Note:

- Pressing the [  ] button again or adjusting volume will unmute.

### Adjust the Volume

Press the [  ] or [  ] button to increase or decrease the volume level.

The adjustable range of volume is 0 to 40.

### Playing Source Selection

1. Press the [  ] button on the panel to show main source menu.
2. Touch the desired icon on the the screen to enter corresponding mode, such as Disc, Navi, Radio, etc.  
Drag left/right to scroll.

#### Note:

- When some devices are not ready, they cannot be selected.
- You should stop switching when the playing source you desired has been selected and wait for some seconds, the unit will auto enter the playing source mode you have selected.

### Video Safety System

The parking brake must be set ON before any video playback can be displayed on the radio's display. If the vehicle is in motion and the parking brake is Off, the unit will play the video from a DVD, USB or SD card to an external monitor. The sound will still be provided by the unit and speakers connected to it.

When video is playing and the parking brake is Off, the unit's display will show the safety warning disclaimer screen.

1. If 'PRK SW' cable is connected to hand brake switch, the video display of the TFT monitor will be controlled by driving status, system setup and input video sources.
2. When the car is moving forward, and a video source is being played, the screen will display a warning disclaimer. The warning screen will prevent the driver from watching images.

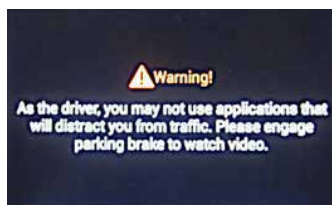

### Customized

To change the icon theme and the wallpaper of the home screens, press the [  ] button.

Swipe through the icons to the "settings" icon. Once in the setting screen, touch "General" then touch "Customized".

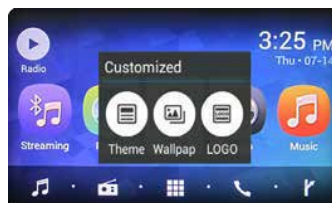

1. **Choose theme:**  
[Theme 1], [Theme 2].  
(Theme 2 is the default theme)
2. **Choose wallpaper from:**  
[Live wallpapers]: to show the wallpapers with animation stored in the unit. Drag up/down to scroll.  
[Photo]: to visit the photo of mobile storage.  
[Wallpapers]: to show the wallpapers stored in the unit. Drag left/right to scroll.  
Select desired picture to view, touch [Set wallpaper] to confirm selection.



## Main menu

### Main Menu

Touch the [  ] button to enter main source menu.





1. Show current player source.
2. Hold and drag down to show the notifications.
3. Car AV system source bar:  
Touch and hold the center of the bar and drag left/right to show more icons.  
Touch desired icon to enter corresponding mode.
4. Clock.
5. Enter music menu. (USB or SD card)
6. Enter radio mode.
7. Show applications list.
8. Enter bluetooth phone mode.
9. Enter NAVI mode.

### Applications Menu

Touch [  ] to enter applications menu.



1. IN-CAR  
Car AV applications.
2. APPS  
Show the Android applications installed.  
In the list menu, drag left/right to scroll.  
Touch and hold an icon for more than 2 seconds to add shortcut to the desktop. To delete the shortcut, hold it and drag to the [  ] on the top, and release after it turns red.  
Touch the [  ] button on the panel to exit.

## Disc Operation

### Insert a Disc

Insert a disc into the slot, and the unit will change to disc mode automatically.

#### Notes:

- Please confirm whether there is a disc in the unit before you insert another one.
- The unit will exit current playing source and enter DVD mode when one disc is inserted.
- The following disc formats are supported: CD-R, CD-RW, DVD-R, DVD+R, DVD-RW, DVD + RW .

### Eject the Disc

Press [  ] on the panel to eject the disc.

Notes:

- After ejecting the disc, the unit reverts to another source automatically.
- If the disc is not removed from the unit within 10 seconds, the disc will be reloaded to prevent accidental damage.

### Disc Playback

When a disc is inserted, the display will show "Loading...". For MP3/WMA or a disc with mixed files, reading time may exceed 1 minute.

### DVD Playback Menu

During playback, touch the screen (except top left corner) to show control buttons.



1. Return to home menu
2. Show DVD menu
3. Progress bar
4. Previous chapter
5. Play/Pause
6. Next chapter
7. Enter preset EQ menu
8. Show more control buttons

# Disc Operation



9. Repeat play
10. To enter search menu
11. Select audio channel
12. Select subtitle language
13. Select viewing angle
14. Hide the second line of control buttons

## CD Playback

Insert a CD in the disc slot, and the unit will read the disc. For some discs, you will need to choose Music/Video/Photo for playback.

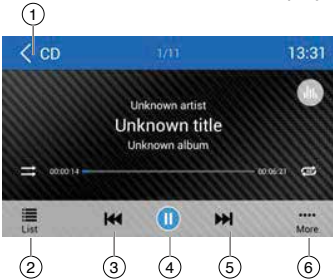

1. Return to home menu
2. Show file list
3. Previous track
4. Play/Pause
5. Next track
6. Show more control buttons



7. Sequential play
8. Repeat play
9. To enter search menu
10. Hide the second line of control buttons

## Mixed Disc Playback

When inserting a mixed disc, the unit will read the disc and show the files list. For some discs, you need to choose Music/Video/Photo to play back.

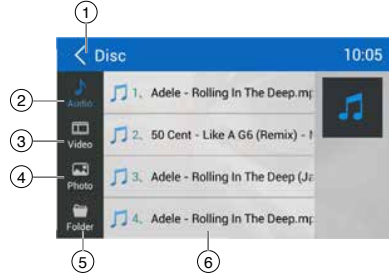

1. Return to home menu
  2. Show music list
  3. Show video list
  4. Show photo list
  5. Show the folders
  6. File/Folder list
- Drag the list up/down to scroll.  
Touch a file name to visit it.

When viewing a picture, touch the screen (except top left corner) to show control buttons.

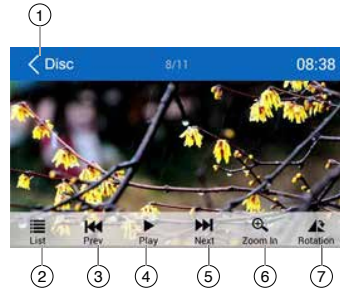



1. Return to home menu
2. Show file list
3. Previous picture
4. Play/Pause
5. Next picture
6. Zoom out/in
7. Rotate clockwise

\* Video/Audio playback reference DVD/CD playback.

## Disc Operation



### Stop Playback Temporarily

---

1. During playback, press [  ] to pause playback. The sound will be muted.
2. Press [  ] to continue playback.

### Select Desired Track/Chapter

---

Press [  ] or [  ] to skip to the previous or next track/chapter.

### Repeat

---

During playback, press [  ] button on screen to select repeat playback.

- Default setting is off.



#### Note:

If you do not select Repeat on, when the entire disc or TITLE playback has finished, the system will stop. If no other control, after 5 minutes the unit will turn into standby mode.

### Sequential Track Playback (for CD/VCD/MP3/WMA Only)

---

You can play all the tracks in random order.

1. During playback, press [  ] button on the screen to select random playback.
2. Press [  ] to select sequential playback.

### Search

---

1. Touch [Goto] on the control bar.
2. Input the chapter number.
3. Touch [OK] to confirm.

### DVD Audio Select

---

Press [  ] button to select audio language to listen if the DVD has multiple audio languages.

### VCD Audio Select

---

Press [  ] button to select audio channel to listen (LEFT, RIGHT, MIXED, STEREO).

### DVD Subtitle Select

---

Press [ Subtitle ] button to select the subtitle language to show if the DVD has multiple language subtitles.

# Radio Operations

Select [Radio] on the main menu to enter radio mode.



1. Return to home menu
2. Tune backward  
Auto tune backward. (long press)
3. Current frequency
4. Tune forward  
Auto tune forward. (long press)
5. Enter EQ menu
6. Enter favorite list
7. Search and store preset stations automatically
8. To receive local / distant radio stations
9. Goto station by inputting frequency
10. Band switch
11. Stations list
12. Show more control buttons



13. Enter customized list
14. Show discovery stations
15. Show favorite stations
16. Mute radio
17. Hide the second line of control buttons
18. Show RDS options

## Select One Radio Band

Touch the [ Band ] button to select one radio band among FM and AM.

## Manual Tuning

During manual tuning, the frequency will be changed in steps.

Touch the [ < ] or [ > ] button on the operation bar to tune in a lower/higher station.

## Auto Tuning

Hold the [ < ] or [ > ] button on the operation bar for more than 2 seconds to seek a lower/higher station.

To stop searching, repeat the operation above or press other buttons having radio functions.

**Note:**

*When a station is received, searching stops and the station is played.*

## Auto Store

Only stations with sufficient signal strength will be detected and stored in the memory.

To start automatic station search, touch the [ Search ] button on the operation bar.

To stop auto store, repeat the operation above or press other buttons having radio functions.

**Note:**

*After auto store, the previous stored stations will be overwritten.*

## Manual store

1. When one expected radio station has been detected, touch [ Heart ] to show customized station store list.
2. Touch to select an item on the list to store the current station in the memory.
3. Touch top left of the screen to exit.

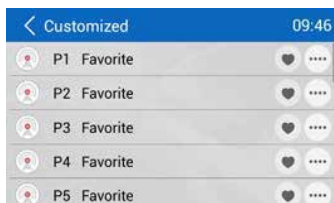

# Radio Operations

## Recall the Stored Stations

Method 1:



1. Touch [  ] button on the screen to show the preset stations.
2. Select a band
3. On the middle of the screen, drag the list left/right to scroll, touch a station on the list to listen to.

Method 2:

1. Touch [  ] button on the screen to show the favorite stations.
2. Select a band
3. On the middle of the screen, drag the list left/right to scroll, touch a station on the list to listen to.
4. Touch top left of the screen to exit.

## Local Seeking

When LOCAL seeking is on, only radio stations with strong radio signal will be received.

To open LOCAL function, touch [  ] button on the operation bar, then touch the [  ] button to select “Loc” or “DX”.

### Note

The number of radio stations that can be received will decrease after the Loc seeking mode is on.

## Key Search

Touch [  ] button on the operation bar to show key search menu.

Touch the keypad to input the frequency, touch [ OK ] to goto the station directly.

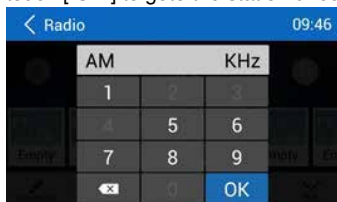

To cancel an input number, touch [  ].

## RDS Basics

Radio Data System (RDS) enables traffic reports to be received and provides many facilities, including enabling the radio station name to be displayed on the radio display.

## Adjust RDS Settings

1. In Radio menu, touch [  ].  
The option menu is displayed.
2. Touch on the selected option to change the setting.
  - [TA]: To turn on or off “TA” function.
  - [AF]: To turn on or off “AF” function.
  - [REG]: To turn on or off “REG” function.
  - [CT]: To turn on or off “Clock Time” synchronization function.
  - [PTY]: To show PTY list.



### TA

Press the TA ON/OFF button to switch the priority for traffic announcements on or off.

### AF

The receiver can automatically switch to an alternative frequency (AF) of the same station if the reception becomes poor. Press the OFF/ON touch-point to turn the automatic scanning for alternative frequencies of an RDS broadcast station off and on.

### CT (Clock Time)

Some stations broadcast the time and date within the encoded RDS signal. The clock time is automatically adjusted when ‘CT’ is set to ‘ON’.

## Radio Operations

### PTY Function

PTY is the abbreviation for Program Type which is a code defining the type of program being broadcast (e.g. News or Rock).

PTY options will display on the screen. To view more PTY options, touch the scroll bar and arrows on the screen.

When one PTY option is touched (e.g. News), auto search for next available PTY by increasing tuning frequency until the PTY of the next station matches the current. If no matched PTY has been found, the unit will return to the original radio frequency.

## SD/USB Operations

### Using a SD Card

1. Open the card slot cap, insert a SD card into the corresponding slot, the unit will load the files automatically.
2. To remove the card, you should first select another source, in order to avoid damaging the card, press the card slightly, and take off the card after it pops out.

### Using USB device

1. Connect your USB device to the USB cable.  
When connecting a USB device, the unit will read the files automatically.
2. To remove the USB device, you should first select another source, in order to avoid damaging the USB device.

### Music Playback

Select [Music] on the applications menu, the unit will display all the music on the mobile storages.

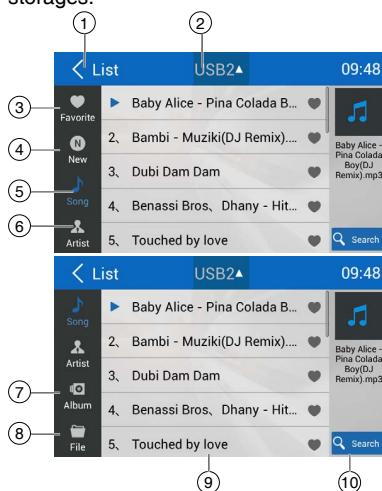

1. Return to home menu
2. Select file source
3. List the files by favorite
4. List the new files
5. List the files by song name  
Touch a song to start play.
6. List the files by artist  
Drag up/down to scroll.
7. List the files by album
8. Show the file

## SD/USB Operations

### 9. List window

Drag up/down to scroll.  
Touch an item to select.

### 10. Enter search menu.

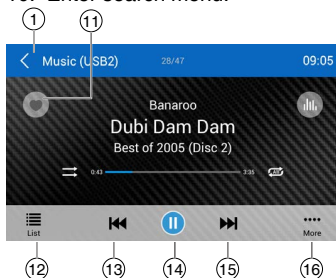

### 11. Favorite

### 12. Show list menu

### 13. Previous track

### 14. Play/Pause

### 15. Next track

### 15. Show more control buttons

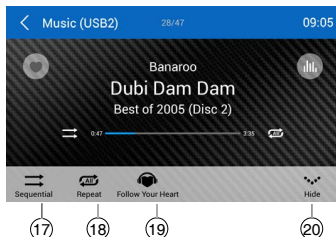

### 17. Sequential play

### 18. Repeat play

### 19. Follow your heart

### 20. Hide the second line of control buttons.

## Play/Pause

When playing, press [ ] button to pause, and the sound will be mute.

Press [ ] button to play.

## Previous/Next Track

Press [ ] or [ ] button to go to previous or next track.

## Select Music by Artist

1. Touch [Artists] on the left of the screen.

2. Touch an artist shown on the list.

3. Select a song to play.

## Select Music by Album

1. Touch [Albums] on the left of the screen.

2. Touch an album shown on the list.

3. Select a song to play.

## Select Music by Song Name

1. Touch [Songs] on the left of the screen.

2. Select a song to play.

## Playlists

### Add a song to favorite playlist

1. Press a song and select [ ].

2. Add it to an favorite playlist.

If choose [Favorite], you need input a name of the playlist.

### Delete a song from favorite playlist

1. Touch [favorite], and select a playlist name on the screen.

2. Press [ ] on the favorite playlist, then remove it from playlist.

## Video Playback

Select [Video] on the applications menu, the unit will display all the video files on the storages.

During playback, touch the screen(except top left corner) to show control buttons.

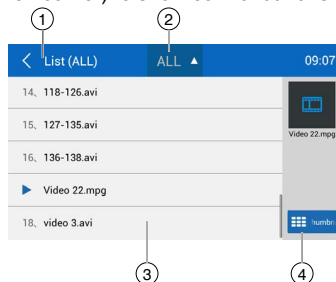

1. Return to home menu

2. Select file source

3. Folder/File list

Drag up/down to scroll, touch to access.

4. Thumbnail

## SD/USB Operations

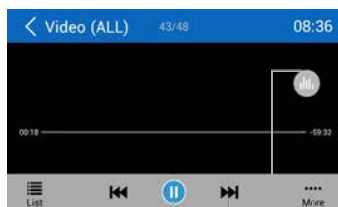

5. Show list menu  
6. Previous chapter  
7. Play/Pause  
8. Next chapter  
9. Enter preset EQ menu  
10. Show more control buttons

5. Show list menu  
6. Previous chapter  
7. Play/Pause  
8. Next chapter  
9. Enter preset EQ menu  
10. Show more control buttons

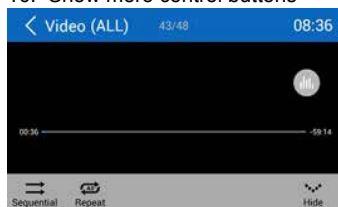

11. Sequential play  
12. Repeat play  
13. Show previous page of control buttons

### Notes

- Disconnect USB storage devices from the unit when not in use.
- Use an optional cable to connect the USB audio player/USB memory as any device connected directly to the unit will protrude out from the unit and may be dangerous.
- Do not use unauthorized products.

## Gallery Operations

1. Select [Photo] on the APPS menu.
2. Select one gallery to show the picture list.



3. Touch to view it.



Drag left/right to scroll.

Touch top left corner to back.



## Bluetooth Operations

The Bluetooth allows you to utilize your car's built-in audio system for handsfree wireless mobile phone or music communication. Some Bluetooth mobile phones have the audio features, and some portable audio players support Bluetooth feature. This system can play audio data stored in a Bluetooth audio device. The car stereo with Bluetooth will be able to retrieve phonebook contacts, received calls, dialed calls, missed calls, incoming calls, outgoing call and listen to music.

### Notes:

- This system will not operate or may operate improperly with some Bluetooth audio players.
- The unit cannot guarantee the compatibility of all mobile phones together with the unit.
- Audio playback will be set to the same volume level as set during telephone call. This can cause problems, if extreme volume level is set during the telephone call.

Touch [] on the main menu to enter Bluetooth Phone mode.



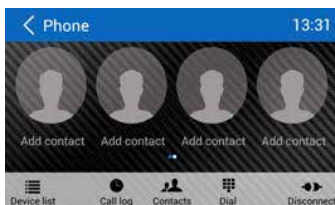

1. If the Bluetooth function of the unit is off, the unit will ask you to turn it on. (Default setting is on)
2. Turn on Bluetooth function of your mobile phone.
3. Search for new Bluetooth devices on your phone. Select "MAG-M6" from the pairing list on the mobile phone, and enter password  
Or touch [  Scan ] button on the screen to search mobile Bluetooth devices.

After connect successfully, the unit show following menu.



## Making a Call

### • Dial Number

1. Input numbers by digit-keys on the screen.  
Touch [  ] to clear the digits.
2. Touch [  ] button to dial out.
3. Touch [  ] button to terminate call.

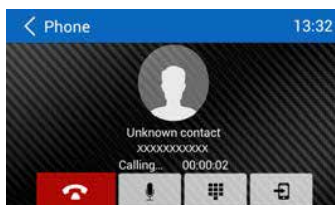

### • Answering a call

You can answer an incoming call by pressing the [] button.

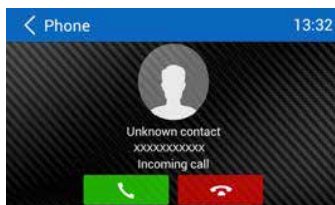

Touch [  ] button to reject an incoming call.



### • Disconnect

To disconnect a paired device, touch [Disconnect] button.

## Call from Phonebook

1. Touch [ Contacts ] button to show your phone book.
2. Select a number to select and touch [  ] button to dial out.
3. Touch [  ] to search a contact name.

# Bluetooth Operations

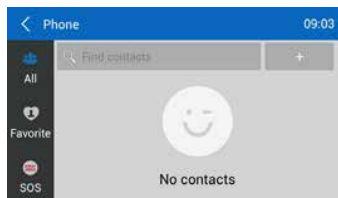

## Call History

Access Call History by touching [ Call log ] button.



Then select a number from Dialed/Missed/Received calls.

## Bluetooth Audio Streaming

### What is audio streaming?

Audio streaming is a technique for transferring audio data such that it can be processed as a steady and continuous stream. Users can stream music from their external audio player to their car stereo wirelessly and listen to the tracks through the car's speakers. Please consult your nearest dealer for more information on the product of wireless audio streaming transmitter offered.

### CAUTION

**Please avoid operating your connected mobile phone while audio streaming as this may cause noise or the sound to cut in and out on playback.**

**Audio streaming may or may not resume after telephone interrupt as this is dependent on your mobile phone.**

Touch [Streaming] button to play music on your mobile phone.

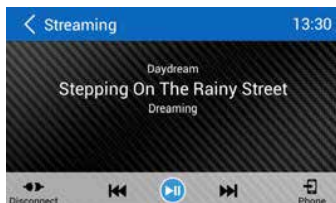

 : Previous track

 : Play/Pause

 : Next track

 : Enter Bluetooth Phone

## Bluetooth Settings

Touch [ Settings ] button to show Bluetooth setting menu.



# iPod/iPhone Operations

This unit supports only the following iPod/iPhone models:

- iPhone 6s Plus
- iPhone 6s
- iPhone 6 Plus
- iPhone 6
- iPhone 5s
- iPhone 5c
- iPhone 5
- iPod touch (6th generation)
- iPod touch (5th generation)



“Made for iPod,” and “Made for iPhone” mean that an electronic accessory has been designed to connect specifically to iPod, or iPhone, respectively, and has been certified by the developer to meet Apple performance standards.

Apple is not responsible for the operation of this device or its compliance with safety and regulatory standards. Please note that the use of this accessory with iPod or iPhone may affect wireless performance.

iPhone and iPod are trademarks of Apple Inc., registered in the U.S. and other countries.

## Accessing iPod mode

Connect an iPod or iPhone to the USB connector via an iPod cable.

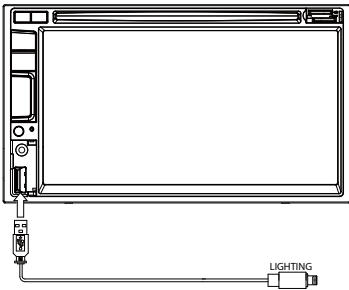

Touch [iPod] on the main menu to enter iPod menu.

If [iPod] isn't on the current menu, slide the bottom bar left or right to find it.

## Pausing play

1. Touch the [⏏] button on the bottom of the screen to pause play.  
“PAUSE” appears in the display, and [⏏] button becomes [▶].
2. Touch [▶] button to resume play.

## Selecting a track

### Track-up

Touch the [▶▶] button to move to the beginning of the next track.

### Track-down

1. Touch the [◀◀] button to move back to the beginning of the current track.
2. Touch the [◀◀] button twice to move back to the beginning of the previous track.

## Fast forward/Fast reverse

### Fast forward

Touch and hold the [▶▶] button .

### Fast reverse

Touch and hold the [◀◀] button .

## Repeat play

This function allows you to play the track repeatedly.

Touch the [🔄] button to select Repeat one or Repeat all.

## Random play

This function allows you to play all tracks recorded in a random order.

Touch the [🎲] button to perform random play.

## Search function

1. Touch the [🔍] button to enter search menu.
2. Input number by touching buttons on the screen, then touch [✓] to begin searching.  
Touch [✕] button to delete inputted number.

## DVR-RECORDER (optional)

Connect car recorder to the unit.  
After connection, user can control the car recorder through DVD screen.  
To access the Recorder menu, touch DVR icon on the main menu.

### Quick instruction

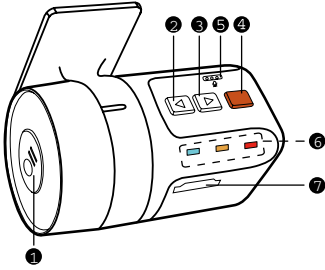

1. Video record/Power
2. Voice record/System
3. File browse/Time setting
4. Emergency backup
5. Mic
6. LED
7. Micro SD Card slot

### Indicator status table

Power	Mute	Record	Function
			Power Indicator
			Mute Off Indicator
			Record(Mute)
			Record(Voice)
			Mute indicator flash indicating the beginning of the emergency backup

Color indicates On, White indicates Off, Slash indicates Flash.

### Cautions of installation

1. Install the car recorder on a dry, clean and safety position by the 3M double-sided tape.
2. Installation temperature range is 15~40°C .
3. If you need to re-install the recorder, replace the 3M double-sided tape by a new one.

## How to export the video file

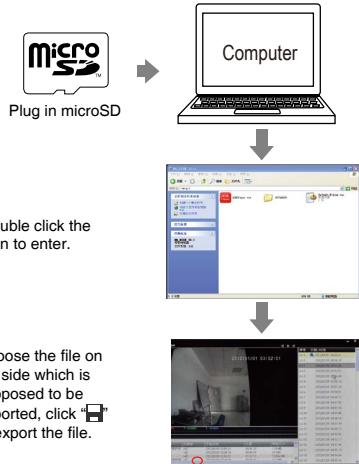

### CAUTION:

When reading the micro SD card on PC, in the case the Anti-virus softwares remind suspicious file or virus files of "ADRPlayer", please click NO on the pop-up window of choice of delete file. In case ADRPlayer was deleted carefully, enter folder of "APPLAYER", copy PLAYER.BIN to the root directory of TF card, rename to PLAYER.EXE for use.

## Settings

### TIME SETTING

1. Press "⏸" to pause record.
2. Long press 5 seconds to enter time setting menu.
3. Press "⏮" to switch year, month, day, hour, minute, second option.
4. Press "⏪" or "⏩" to switch the current option.
5. After setup, long press 5 seconds "⏩" to exit time setting menu.

### PAL/NTSC SWITCH

Press "⏸" to stop record, blue LED off light.  
Long press 5 second "⏪" to switch PAL/NTSC.

# SiriusXM Satellite Radio

## SiriusXM® Satellite Radio

---

The device can be used for SiriusXM satellite radio play-back.

**Note:**

For the SiriusXM satellite radio playback, an optional SiriusXM Connect Vehicle Tuner must be connected.

Only SiriusXM® brings you more of what you love to listen to, all in one place. Get over 140 channels, including commercial-free music plus the best sports, news, talk, comedy and entertainment. Welcome to the world of satellite radio. A SiriusXM Vehicle Tuner and Subscription are required. For more information, visit [www.siriusxm.com](http://www.siriusxm.com).

## Activating your SiriusXM Subscription

---

After installing your SiriusXM Connect Vehicle Tuner and antenna, power on your device and select SiriusXM mode. You should be able to hear the SiriusXM preview channel on Channel 1. If you cannot hear the preview channels, please check the installation instructions to make sure your SiriusXM Connect tuner is properly in-stalled.

After you can hear the Preview channel, tune to Channel 0 to find the Radio ID of your tuner. In addition, the Radio ID is located on the bottom of the SiriusXM Connect Vehicle Tuner and its packaging. You will need this number to activate your subscription. Write the number down for reference.

**Note:** The SiriusXM Radio ID does not include the letters I, O, S or F.

In the USA, you can activate online or by calling SiriusXM Listener care:

- Visit [www.siriusxm.com/activatenow](http://www.siriusxm.com/activatenow)
- Call SiriusXM Listener Care at 1-866-635-2349

For Canadian Subscriptions, please contact:

- Visit [www.siriusxm.ca/activatexm](http://www.siriusxm.ca/activatexm)
- Call XM Customer Care at 1-877-438-9677

As part of the activation process, the SiriusXM satellites will send an activation message to your tuner. When your radio detects that the tuner has received the activation message, your radio will display: "Subscription Updated".

Once subscribed, you can tune to channels in your subscription plan. Note, the activation process usually takes 10 to 15 minutes, but may take up to an hour. Your radio will need to be powered on and receiving the SiriusXM signal to receive the activation message.

## SiriusXM features

---

This device supports the following SiriusXM features:

• **Parental Control**

The Parental Control feature allows you to limit access to SiriusXM channels with mature content. When enabled, the Parental Control feature requires you to enter a passcode to tune to the locked channels. Information on setting up the passcode and locking channels can be found in the sections "Options menu" and "List mode displays", subsection "Parental Control display".

• **Replay**

The Replay feature allows you to pause, rewind and replay live SiriusXM Satellite Radio programming. Operation of the Replay feature can be found in the section "SiriusXM replay display".

• **SmartFavorites**

SmartFavorites allow you to rewind and replay any missed programming from your Preset Channels List. Miss a music, news, talk or sports segment? No Problem, because you can rewind and replay when you tune to one of your Preset channels and hear what you missed.

• **TuneStart™**

With the TuneStart™ feature turned ON, you will hear the beginning of the song when you tune to one of your Preset channels. It may take a minute or two for the feature to work after power up or after changing preset bands. Information for turning TuneStart On or Off can be found in the section "Options menu".

**Note:**

SmartFavorites and TuneStart are compatible with SXV200 and tuner models. SXV200 will limit the features to the first 6 Favorite Channels in your Preset list.

## Starting SiriusXM playback

---

In the Car AV applications, select the SiriusXM app. The SiriusXM main display opens and playback starts.

# SiriusXM Satellite Radio

## SiriusXM main display



The SiriusXM main display features the following functions and displays:

1. Changing to the main menu
2. Channel info area:
  - Current channel number and preset number (if applicable)
  - Current channel name
  - Current channel category
  - Current title information
3. SiriusXM field strength
4. Time
5. Changing to the replay display
6. Display the Direct Entry Menu.
7. Tune to the previous channel
8. Toggling between seek tuning through all categories and seek tuning in the current category only
9. Tune to the next channel.
10. Go to SiriusXM® Menu Page 2.

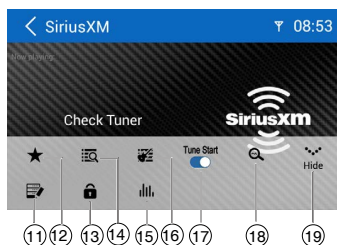

11. Go to the change password screen.
12. Opens the preset list
13. Display the SXM Lock Screen.
14. Opens the channel list
15. Touch to access the Equalizer level settings menu
16. Opens the category list
17. Tune on/off
18. Touch to scan all channels starting at

channel 1

19. Go to SiriusXM® Menu Page 1

## Seek Tuning

- To tune to the next higher channel, touch the [ >>> ] icon and to scroll through the higher channels touch and hold the [ >>> ] icon.
- To tune to the next lower channel, touch the [ <<<< ] icon and to scroll through the lower channels touch and hold the [ <<<< ] icon.

## Direct Tuning

To enter a SiriusXM® radio channel directly:

1. On the SiriusXM® menu, touch [ ■■■ ] icon to display the Direct Entry Menu.

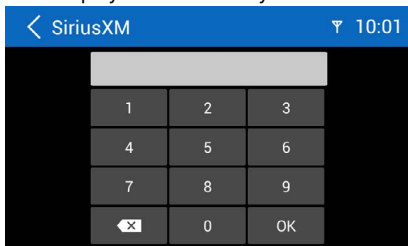

2. Enter the desired SiriusXM® radio channel using the on-screen number pad then touch the [OK] icon. If you wish to delete an entry number touch the [ X ] icon.
3. To exit the screen without changing the channel, touch [ < ] icon.

## Using Preset Channels

A preset is a channel name that is stored for an instant access to that channel. Ten numbered preset buttons store and recall channels for each band.

### Storing a Channel

1. On the SiriusXM® menu page 2, touch [ ★ ] icon to access the Preset Channel Screen.
2. Touch the preset number (P1 through P18) in which you would like to store the current channel (or touch the [ < ] icon to cancel and close the menu).  
The channel will be stored and displayed in

# SiriusXM Satellite Radio

that preset. Drag up/down to scroll.

3. Touch the [ < ] icon to return to the SXM Menu screen.

## Recalling a Channel

1. Touch the Preset icon to access the Recall Preset Channel Screen.
2. Touch a channel on the preset channel list to select the corresponding stored channel. Drag up/down to scroll.



## Searching for a Channel

### Search by Channel

1. On the SiriusXM® menu, touch the [ 🔍 ] icon (if needed) to select Channel.
2. Touch List to display the Channel Search Screen.
3. Touch a channel to tune to that channel. Drag up/down to scroll.

### Search by Category

Categories group music by type such as jazz, rock, classical, etc. To search by category:

1. On the SiriusXM® menu, touch the [ 📁 ] icon (if needed) to select Category.
2. Touch List to display the Category Search Screen.
3. Touch a category item. A channel list screen appears.
4. Touch a channel to tune to that channel. Scroll up or down the list.

## Locking Individual SXM Channels

A user can lock individual channels. When locked, a channel has the lock icon next to it on the channel list.

### Locking a Channel

To lock an individual channel:

1. On the SiriusXM® menu page 2, touch [ 🔒 ] icon. The following screen appears:

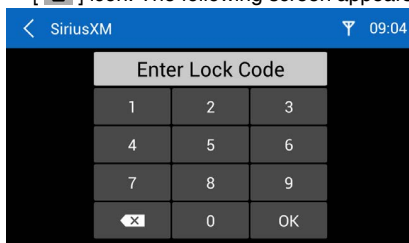

2. Enter your 4-digit password and then press the OK icon.

### Unlocking a Channel

To unlock an individual channel:

1. On the SiriusXM® menu page 2, touch [ 🔒 ] icon. The Enter Password Screen appears.
2. Enter your 4-digit password.
3. Touch a lock icon to unlock a channel. The icon is replaced by an unlocked icon. The channel is now unlocked.

## Change Lock Password

The Change Lock Password option allows you to change the password from current custom password to another password.

To change a password:

1. Touch the [ 🗝 ] icon.
2. Enter your 4-digit password and press the OK icon.
3. Enter the new 4-digit password and press the OK icon. The new password is set.

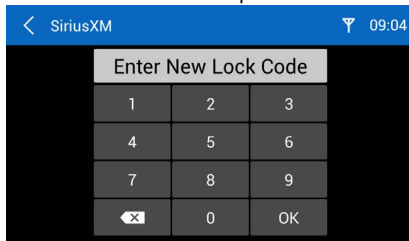

## Wi-Fi Settings

1. Connect the WiFi dongle to the unit. Touch the [ Settings ] icon on the main menu to enter setting menu, and turn on Wi-Fi (if necessary).



2. Touch [ Wi-Fi ] to enter WiFi setting menu.



3. Touch an available WiFi hotspot.



4. Touch [ Password ] and input the password, touch [Connect] to confirm.



5. After successfully connected, the [  ] icon appears on the top right corner of the main menu . Now you can access internet.



## Visit Website

To access the internet, you must setup "wireless & network" in system settings menu.

Select [  ] on the main menu to view a website.

Touch the dialog box on the upper side of the screen to show keypad. Input the website address, and touch [Go] to visit it. Drag the web page to scroll.

## E-mail

Select [Email] or other mail software on the applications menu.

First you must setup an account, or sign into an existing account. Enter your Email address and password. Then you can send/receive E-mails through the unit.



## Navigation Operations

To navigate by the unit, simply select the desired navigation application on the main menu. Then navigate by the touch screen.

## AUX Operations

Select [A/V In 1]/[A/V In 2] on the main menu to visit auxiliary device.

## File Explorer

Select [File Explorer] on the applications menu to view the files and folders on the SD card. The USB files and folders are in the folder named "external\_usb". You can install applications and edit files/folders.

Select [EQ] on the menu to enter sound setting mode.

Touch to select a preset EQ on upper side of the screen from Flat, Pop, User, Rock, Techno, Classic, Jazz and Optimal.

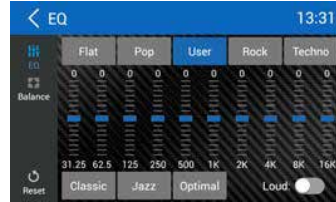

[  Loud ]: When listening to music at low volumes, this feature will selectively boost certain bass and treble frequencies.

Touch [Speaker icon] to enter Fader/Balance/Subwoofer setting menu.

Touch [◀] or [▶] to setup Balance, touch [▲] or [▼] to setup Fader.

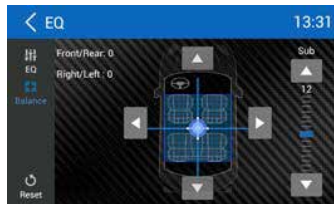

Sub woofer Level: Touch [▲] or [▼] to adjust subwoofer Level.

# System settings

## Display System

---

1. Touch the upper left corner to display main menu.
2. Touch [ Settings ].  
The settings menu is displayed.
3. Touch the upper left corner of the screen to exit.

## Adjust General Settings

---

1. Touch [ General ].
2. Touch to select a setting.
3. Touch on the option to display/select an option.

General settings	Options	Description
Lighting	You can select the key color.	
Customized	See page 6 for reference.	
Radio region	Select one that matches your location.	
Microphone	Internal	Internal microphone for Bluetooth calls.
	External	External microphone for Bluetooth calls.
Blackout	Choose screen blackout off, 15s or 30s.	
Fast boot	Choose fast boot off, 1 day , 3 days or 5 days.	
Beep	On	Turn on the beep sound. Each time you press a button, the unit beeps.
	Off	Turn off the beep sound.
Quick gesture operations definition.		

## Adjust Video Settings

---

1. Touch [Video].
2. Touch an option repeatedly to select.

Video settings	Opciones	Descripción
Video output	NTSC/PAL	Choose video output mode.
Camera Settings	Choose rear/left/right camera display mode.	

## Adjust Time Settings

---

1. Touch [ Time ].
2. To setup Date & time.

## Adjust Volumes Settings

---

Choose input volume gain of each source.

1. Touch [Volumes].  
The volume setting sub-menu is displayed.
2. Touch on a source, to assign value: 0 to 40.  
When switching to the source, the volume increases automatically.

## System settings

### Adjust Disc Rating

---

1. Touch [Disc].
2. Touch an option repeatedly to select.

DVD rating	Options	Description
Audio		Select DVD audio language. Options available depending on DVD disc.
Subtitle		Select DVD subtitle language. Options available depending on DVD disc.
Disk Menu		Select DVD menu language. Options available depending on DVD disc.
AgeControl	KID SAF	Acceptable for children.
	G	Acceptable for general viewers.
	PG	Parental guidance suggested.
	PG 13	Unsuitable for children under age 13.
	PGR	Recommend parents to restrict viewing for children under 17 .
	R	Restricted re parental guidance is advised for children under the age of 17 .
	NC17	Unsuitable for children under age 17.
ADULT	Acceptable for adults only.	
Parental		Set password to restrict the play of discs. The default password is 000000.

### Network

---

To setup the wireless configuration, such as Wi-Fi.

\* For Wi-Fi settings, refer to "Internet".

### Personal

---

To setup Location access, Security, Language & input, Factory data reset, All data erase, Accounts, etc.

### Device

---

To setup Brightness, Storage, Apps.

## System settings

---

### Accessibility

To setup accessibility related applications.

You need download a screen reader and establish an account.

### Software version

To view software version information.

### UUID QR code

To view UUID QR code information.

## Device Connections

### Notes of connection

- This unit is designed to be used in a vehicle with a 12-volt battery and negative grounding. Before installing this unit to a recreational vehicle, a bus, or a truck, make sure the battery voltage is appropriate for this unit to be used, otherwise, have a professionally installed transformer to convert the output voltage to 12V.
- To avoid short circuit in the electrical system, ensure that the negative battery cable is disconnected before installation.
- To prevent short circuit in the wiring and damaging to this unit, secure all wirings with cable clamp or adhesive tape. Route the wirings in a secured, out of heating place without touching any moving parts such as gear shift, handbrake, and seat rails to prevent the wiring insulation being melted / worn off.
- Never pass the yellow power cord through the installation hole into the engine compartment and connect to the car battery. Otherwise, a high possibility of serious short circuit to the electrical system may occur.
- If you need to replace the fuse, please replace with a 15A fuse. Using no fuse or a fuse with an improper rating may cause damage to the unit or a potential fire. If a proper fuse is installed and problems continue to occur, please contact your local retailer or installer.
- DO NOT connect other equipments with the car battery to avoid battery overheating.
- Please make sure all the wiring connections & the cables of the speakers are well-insulated. Otherwise, this unit may be damaged by short circuit.
- If there is no ACC available, please connect ACC lead to the power supply with a switch.
- If an external power amplifier is connected, please don't connect P.CONT lead to the power lead of the external power amplifier, otherwise, electric spark or other damage may result.
- Never ground the speaker output to prevent the damage to the built-in power amplifier.

# Device Connections

## Parking Brake Cable Connections

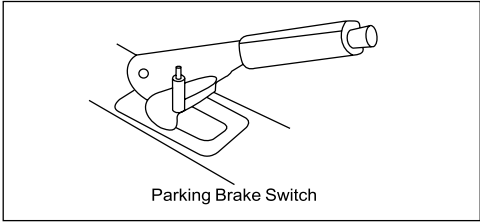
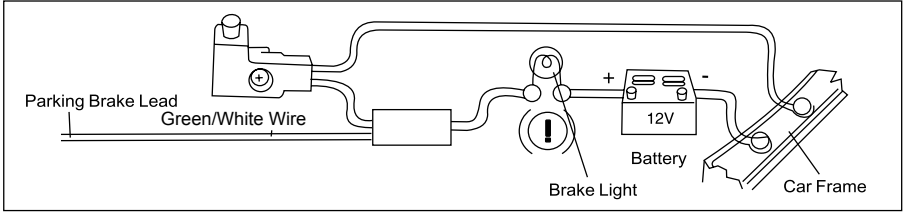

# Device Connections

## Wiring Diagram

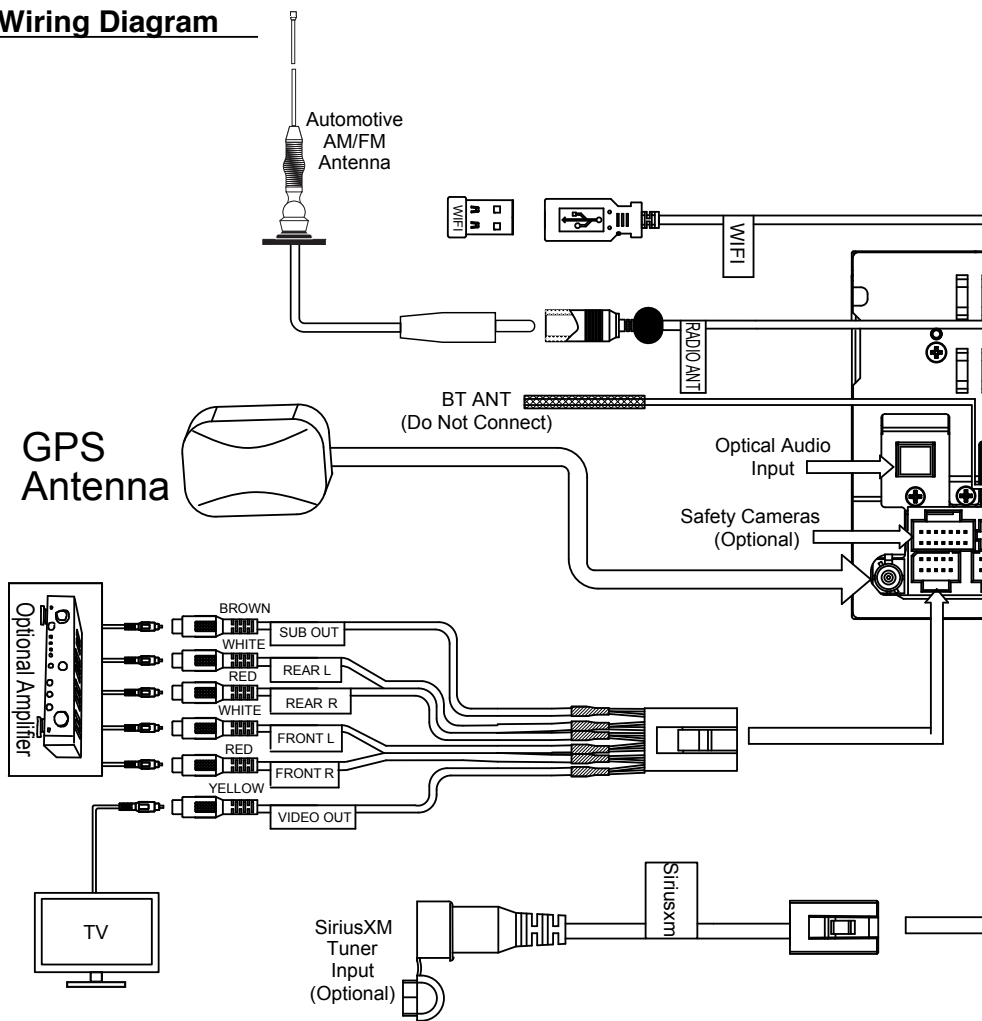

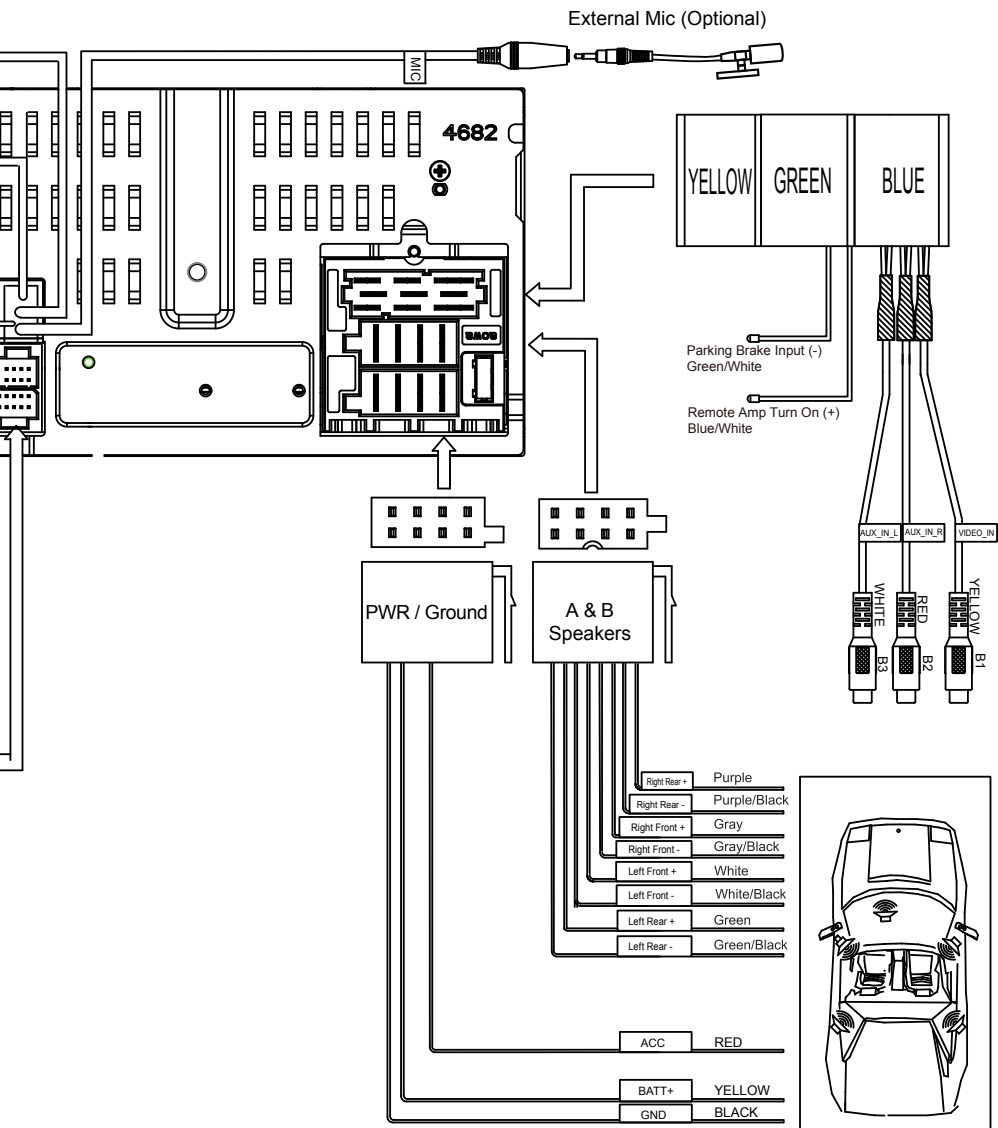

## Troubleshooting

The following checklist can help you solve the problems which you may encounter when using the unit. Before consulting it, check the connections and follow the instructions in the user manual.

Problem	Possible cause	Solution
<b>General</b>		
The unit will not switch on.	Car ignition is not on. Cable is not properly connected. Fuse is burnt.	Turn your car key in the ignition. Check cable connection. Replace fuse with a new fuse of the same capacity.
No sound	Volume is set at minimum or the mute function is on.	Check the volume or switch the mute function off.
The unit or screen does not function normally.	The unit system is unstable.	Press the RESET button.
<b>Remote control</b>		
The remote control is not working or does not work properly	The battery is low or empty.	Change the batteries.
<b>DVD mode</b>		
The appliance will not play discs.	The disc is inserted incorrectly. The disc is dirty or damaged.	Disc must be inserted with the label side facing up. Clean the disc and check for damage. Try another disc.
Sound skips due to vibration.	Mounting angle is over 30°. Mounting is unstable.	Adjust mounting angle to less than 30°. Mount the unit securely with the supplied parts.
<b>TUNER mode</b>		
Unable to receive stations.	The antenna is not connected properly.	Connect the antenna properly.
Poor quality reception of radio station.	The antenna is not fully extended or it is broken.	Fully extend the antenna and if broken, replace it with a new one.
Preset stations are lost.	The battery cable is not properly connected.	Connect the permanent live on the unit to the permanent live on the vehicle.
<b>USB mode</b>		
Unable to insert USB device.	The USB device has been inserted the wrong way round.	Insert USB the other way around.
The USB device cannot be read.	NTFS format is not supported.	Check that the USB disk file system is in FAT or FAT32 format. Due to different formats, some models of USB storage devices or MP3 players may not be read.



# Specifications

## General

Reference Supply Voltage.....	12V(DC)
Operating Voltage Range.....	10.5 - 15.8V(DC)
Max Operating Current.....	15A
Grounding System.....	Car Battery Negative Pole
Dimensions(WXHXD).....	178 x 101.5 x 166.9mm
Weight(main unit).....	1.84kg

## FM

Signal Noise Ratio.....	≥55dB
Usable Sensitivity(S/N=30dB).....	≤15dBμV
Frequency Response(-3dB).....	20Hz~7KHz
Station Seeking Level.....	20~28dBμV
Distortion.....	≤1.0%
Stereo Separation(1KHz).....	≥25dB
Antenna Impedance.....	75Ω

## AM

Usable Sensitivity(S/N=20dB).....	≤30dBμV
Frequency Response(-3dB).....	50Hz~2KHz

## LCD

Screen size.....	6.75 inches(16:9)
Display resolution.....	800X480dots

## DVD Player

Signal / Noise Ratio.....	≥70dB
Dynamic Range.....	≥70dB
Distortion(line out).....	≤0.8%
Frequency Response(±3dB).....	20Hz~20KHz
Maximum Output Power.....	4×30W
Load Impedance.....	4Ω

## AUX IN

Distortion.....	≤0.8%
Frequency Response(±3dB).....	20Hz~20KHz
Audio Input Level.....	500mV

## Audio

Audio Output Impedance.....	10KΩ
Audio Output Level.....	2Vrms(Max)

## Video

Normal Video Input Level(CVBS).....	1.0±0.2V
Video Input Impedance.....	75Ω
Video Output Impedance.....	75Ω
Video Output Level.....	1.0±0.2V

## Environment

Operating Temperature.....	-10°C ~ +60°C
Storing Temperature.....	-20°C ~ +70°C
Operating Humidity.....	45%~80%RH
Storing Humidity.....	30%~90%RH

## Notice:

When the unit is operated in extreme conditions, such as operated with maximum power output for a long time, or the temperature is over 70°C, it will enter heat protection mode, the volume will automatically be lowered. This is normal.

## FCC Statement

1. This device complies with Part 15 of the FCC Rules. Operation is subject to the following two conditions:
  - (1) This device may not cause harmful interference.
  - (2) This device must accept any interference received, including interference that may cause undesired operation.
2. Changes or modifications not expressly approved by the party responsible for compliance could void the user's authority to operate the equipment.

NOTE: This equipment has been tested and found to comply with the limits for a Class B digital device, pursuant to Part 15 of the FCC Rules. These limits are designed to provide reasonable protection against harmful interference in a residential installation.

This equipment generates uses and can radiate radio frequency energy and, if not installed and used in accordance with the instructions, may cause harmful interference to radio communications. However, there is no guarantee that interference will not occur in a particular installation. If this equipment does cause harmful interference to radio or television reception, which can be determined by turning the equipment off and on, the user is encouraged to try to correct the interference by one or more of the following measures:

- Reorient or relocate the receiving antenna.
- Increase the separation between the equipment and receiver.
- Connect the equipment into an outlet on a circuit different from that to which the receiver is connected.
- Consult the dealer or an experienced radio/TV technician for help.

### FCC Radiation Exposure Statement

This equipment complies with FCC radiation exposure limits set forth for an uncontrolled environment. This equipment should be installed and operated with minimum distance 20cm between the radiator & your body.

## Warranty

### ONE (1) YEAR LIMITED WARRANTY

Magnadyne Corporation or its authorized agents will within one year from the date of sale to you, repair, replace or refund the retail sales price of said product or any part thereof, at the option of the Magnadyne Corporation or its authorized agents, if said product or part is found defective in materials or workmanship, when properly connected and operating on the correct power requirements designated for the specific product. This warranty and Magnadyne Corporation or its authorized agent's obligations hereunder do not apply where the product was; damaged while in the possession of the consumer, subjected to unreasonable or unintended use, not reasonably maintained, utilized in commercial or industrial operations, or serviced by anyone other than Magnadyne Corporation or its authorized agents, or where the warning seal on the product is broken or the power and/or plugs are detached from the unit. Magnadyne Corporation or any of its authorized agents will not assume any labor costs for the removal and reinstallation of any product found to be defective, or the cost of transportation to Magnadyne Corporation or its authorized agents. Such cost are the sole responsibility of the purchaser.

This warranty does not cover the cabinet appearance items or accessories used in connection with this product, or any damage to recording or recording tape, or any damage to the products resulting from improper installation, alteration, accident, misuse, abuse or acts of nature.

MAGNADYNE CORPORATION OR ITS AUTHORIZED AGENTS SHALL NOT BE LIABLE TO ANYONE FOR CONSEQUENTIAL OR INCIDENTAL DAMAGES OR CLAIMS EXCEPT THOSE ACCORDED BY LAW. NO EXPRESSED WARRANTY OR IMPLIED WARRANTY IS GIVEN EXCEPT THOSE SET FORTH HEREIN. NO IMPLIED WARRANTY SHALL EXTEND BEYOND ONE YEAR FROM THE DATE OF SALE.

This warranty extends only to the original purchaser of the product and is not transferable. Some states do not allow limitations on how long an implied warranty lasts, and some states do not allow the exclusion or limitation of incidental or consequential damages, so the above limitations or exclusion may not apply to you. This warranty gives you specific legal rights, and you may have other rights that vary from state to state.

**“NOTE: The manufacturer is not responsible for any radio or TV interference caused by unauthorized modifications to this equipment. Such modifications could void the User's authority to operate the equipment.”**

Defective merchandise should be returned to the original point of purchase or secondly, to Magnadyne Corporation, 1111 W. Victoria Street, Compton CA 90220. Return Authorization must be obtained before sending, or merchandise may be refused.

